



The Future of Hydropower - Adapting to Climate Change

Carl Andreas Veie

NVE

28.11.2023 –

User Meeting Hydro Scheduling





Content

- A look at the inflow statistics for the last few years
- Results from the 2019 report on the impact of climate change on hydropower - with updated hydropower dataset
- Some recent and ongoing work in NVE



Photo: Trond Reitan



Photo: [Tommy Gildseth](#)



Photo: Gisle Oddstad / VG



Photo: Private



Is this the new future?



Annual net inflow 2020-2023 (so far)

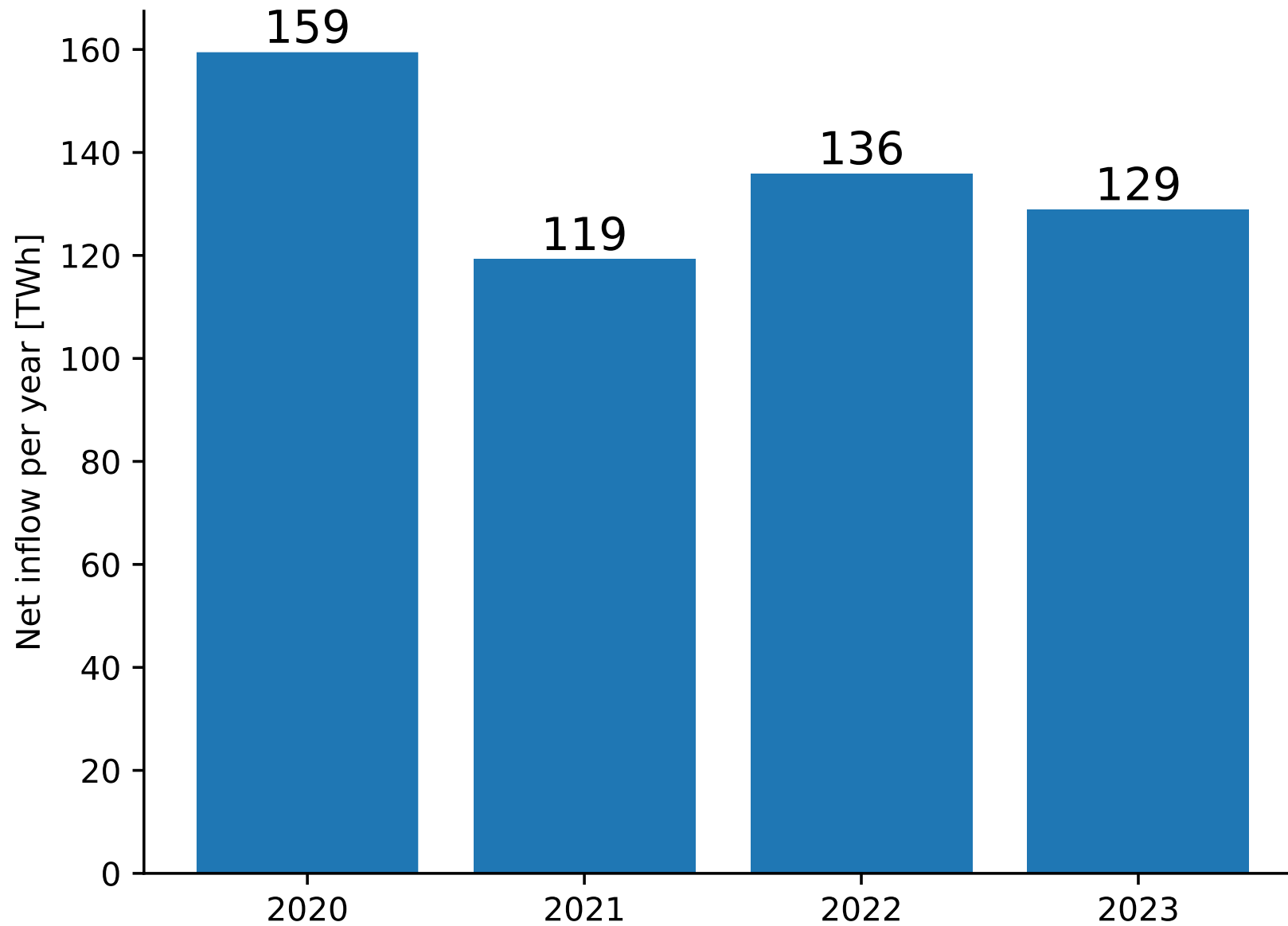



Cumulative net inflow 2020-2023 (so far)

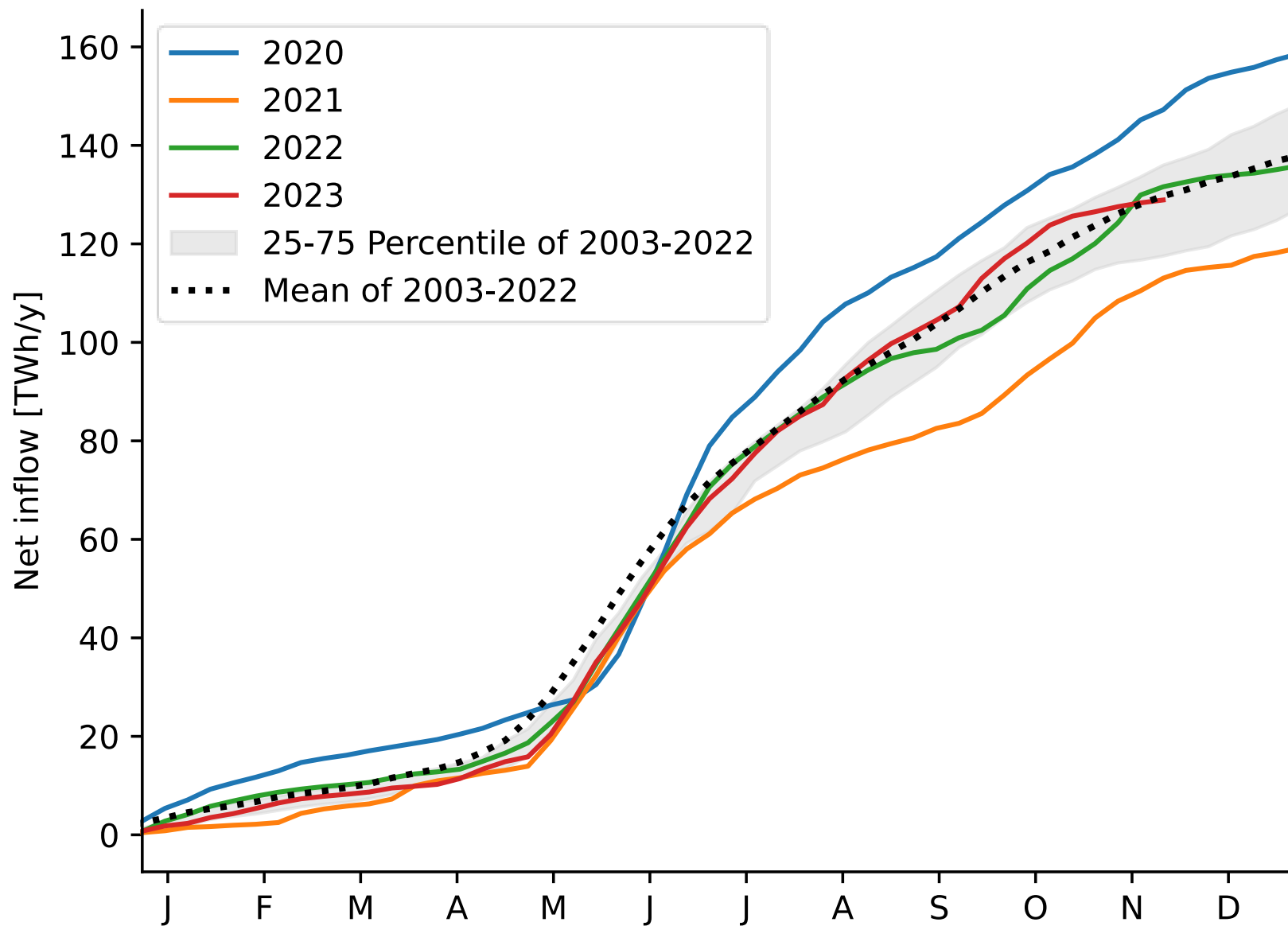

Cumulative net inflow 2020-2023 (so far)

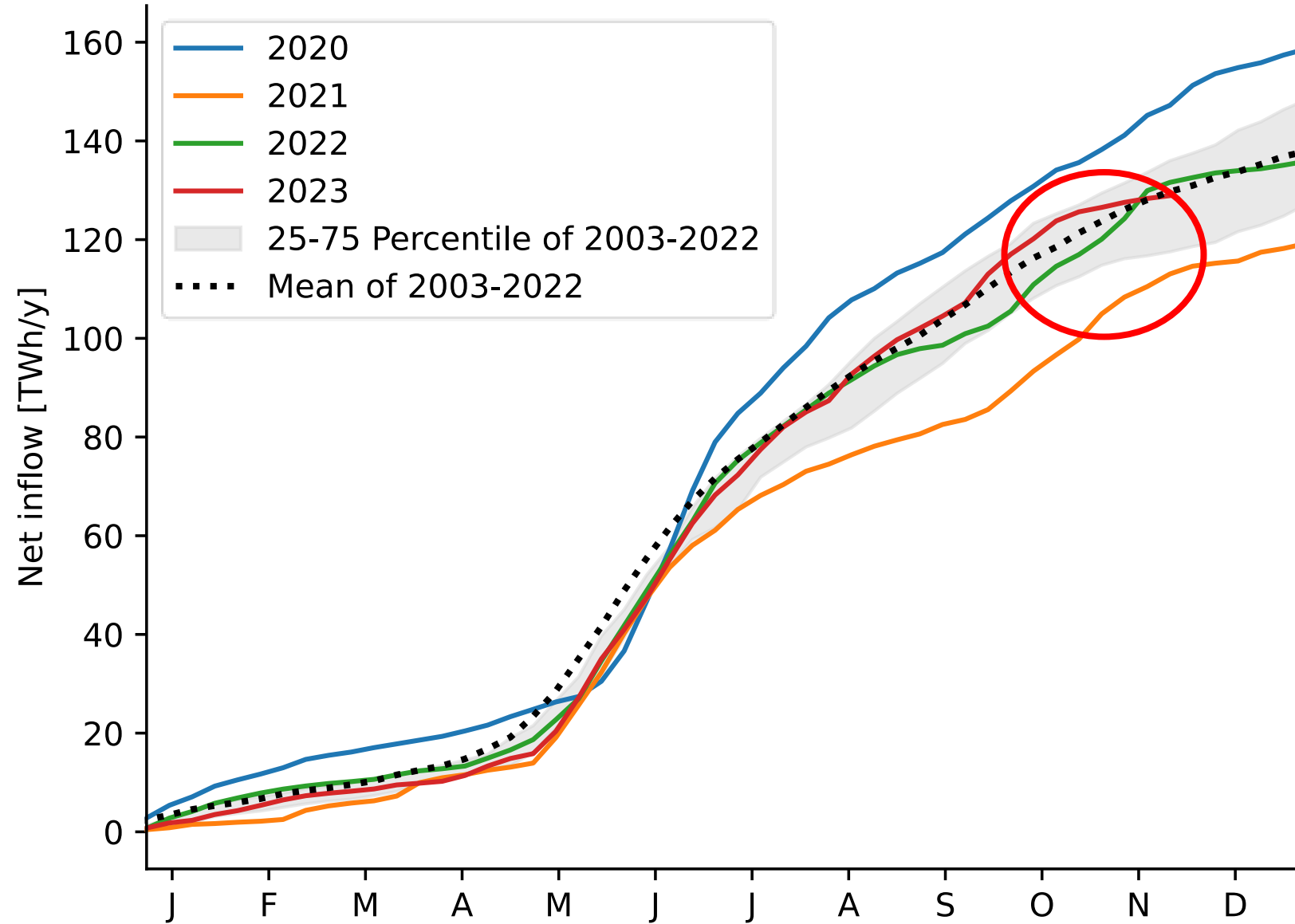



Inflow for NO1, NO2 and NO5

[← Tilbake til rapport](#)

NYTTBART TILSIG PER UKE [GWH]

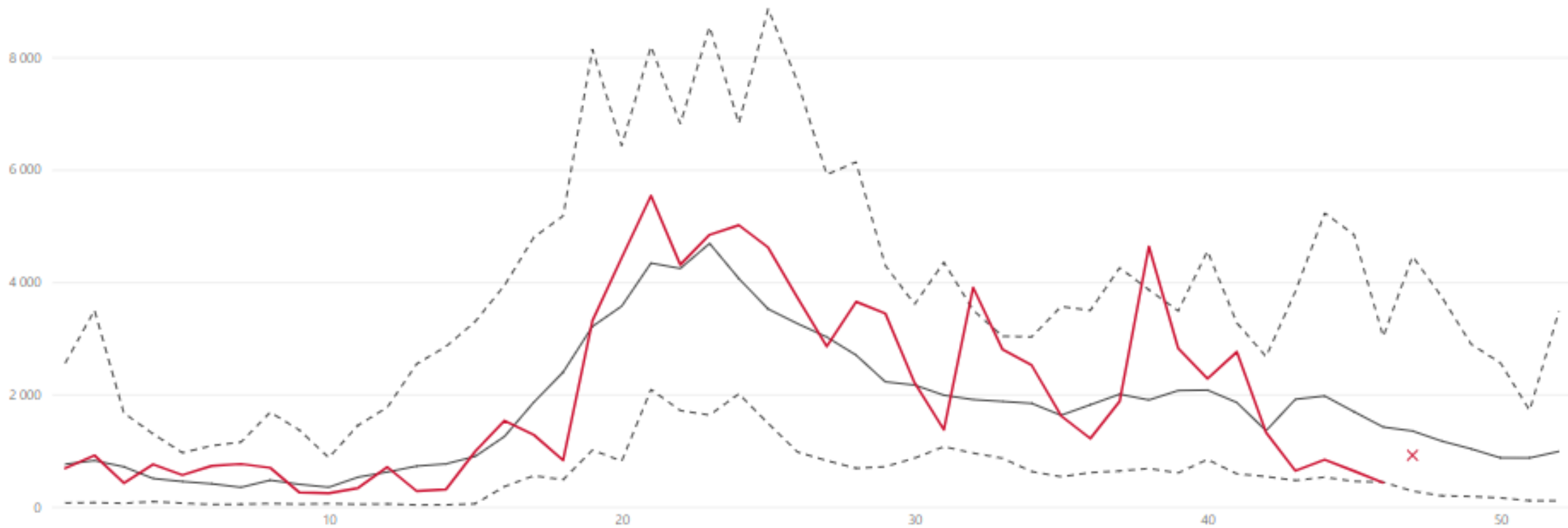



Inflow for NO1, NO2 and NO5

< Tilbake til rapport

NYTTBART TILSIG PER UKE [GWH]

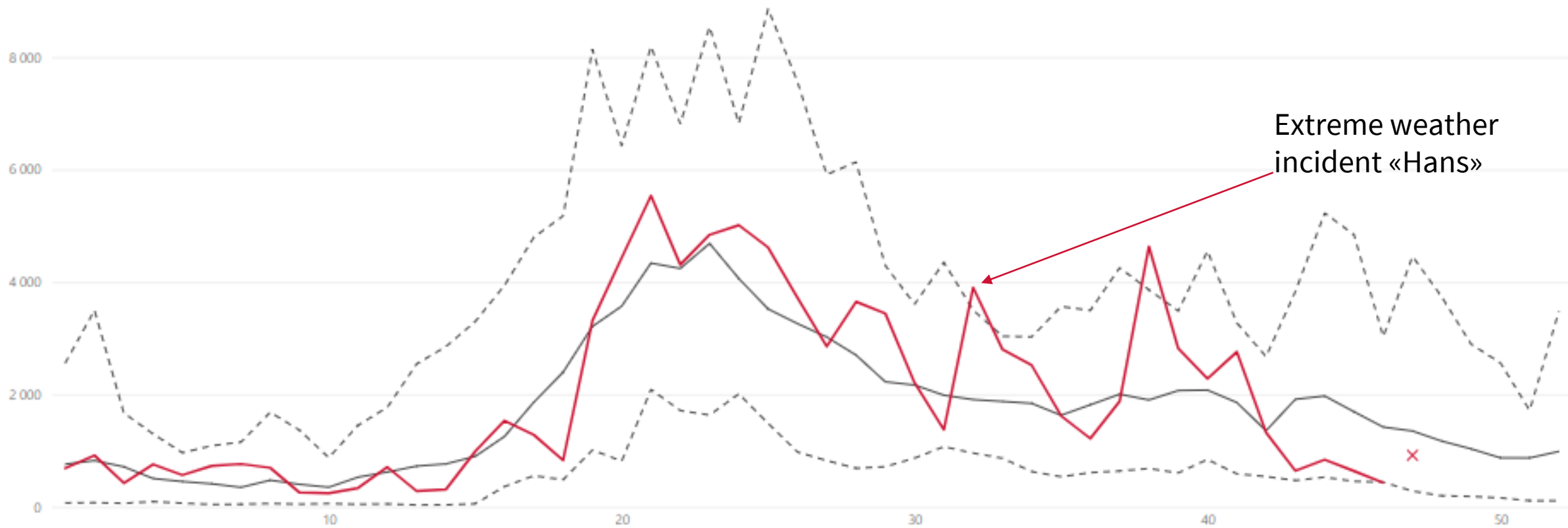



Hvor er nedbøren mest verd?

Kartet viser nedbørsfeltene til vannkraftverkene i Norge. Nedbørsfeltene er farget etter hvor mye energi man får fra hver dråpe nedbør gjennom kraftverkene på vei ned til havet. En sumenergikvivalent på 1 betyr at man får 1 kWh med strøm for 1 m³ vann. Dette er direkte proporsjonalt med den utnyttede fallhøyden og virkningsgraden til kraftverkene i kaskaden. En energikvivalent på 1 tilsvarer et fall på omtrent 400 m.

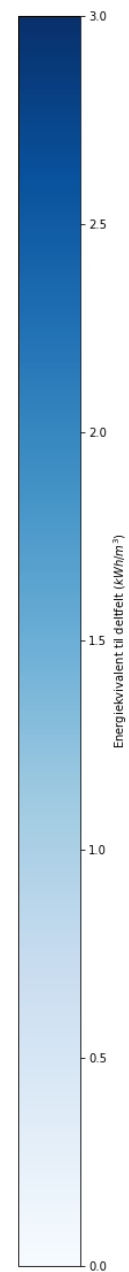
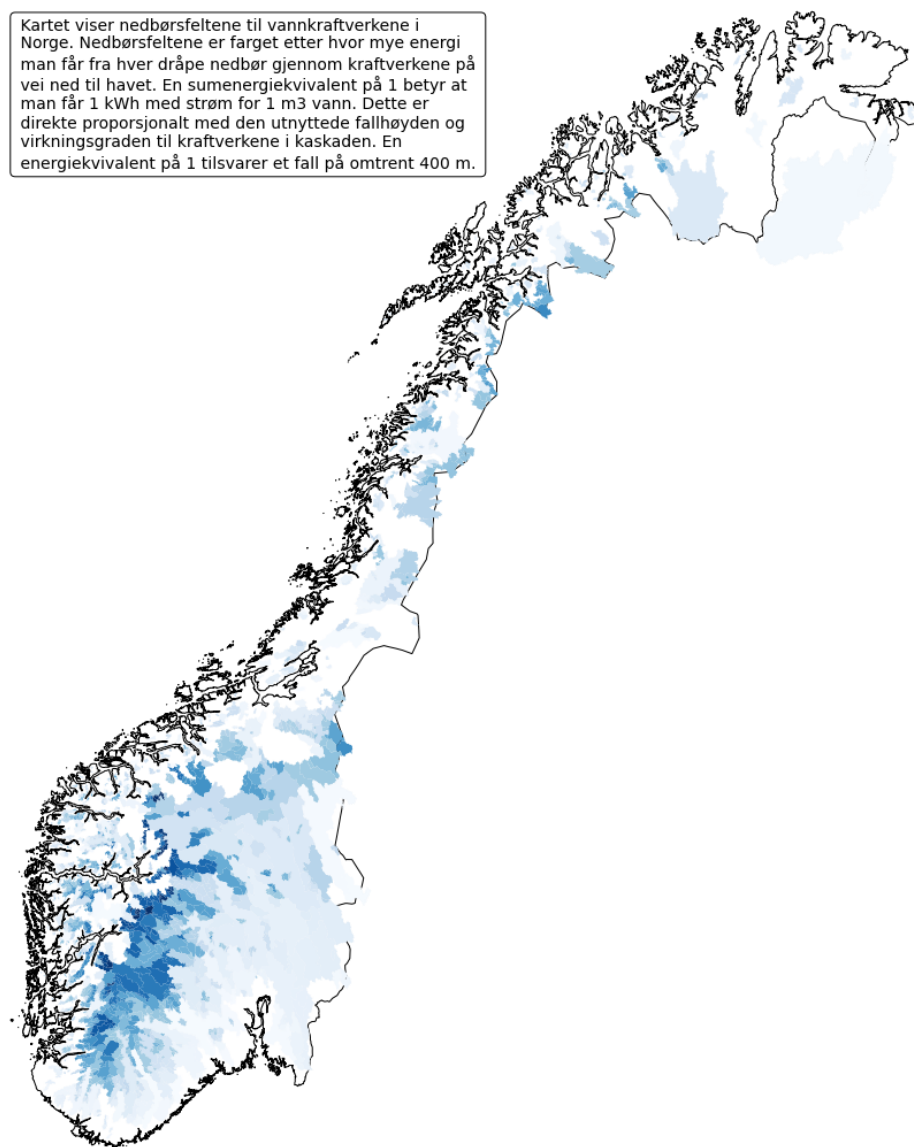



Inflow from observed discharge in Norway 30 years rolling mean

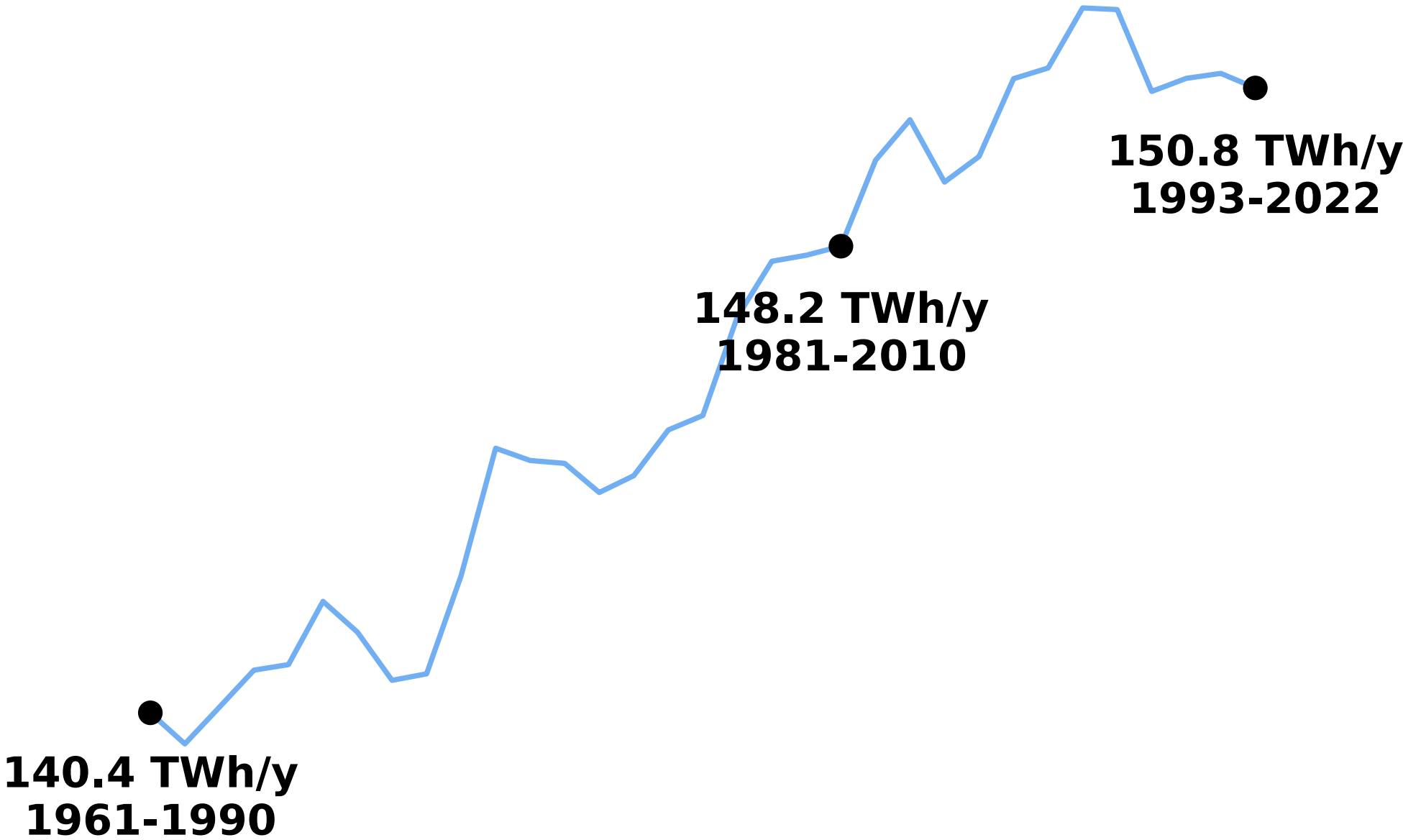

Inflow from observed discharge in Norway

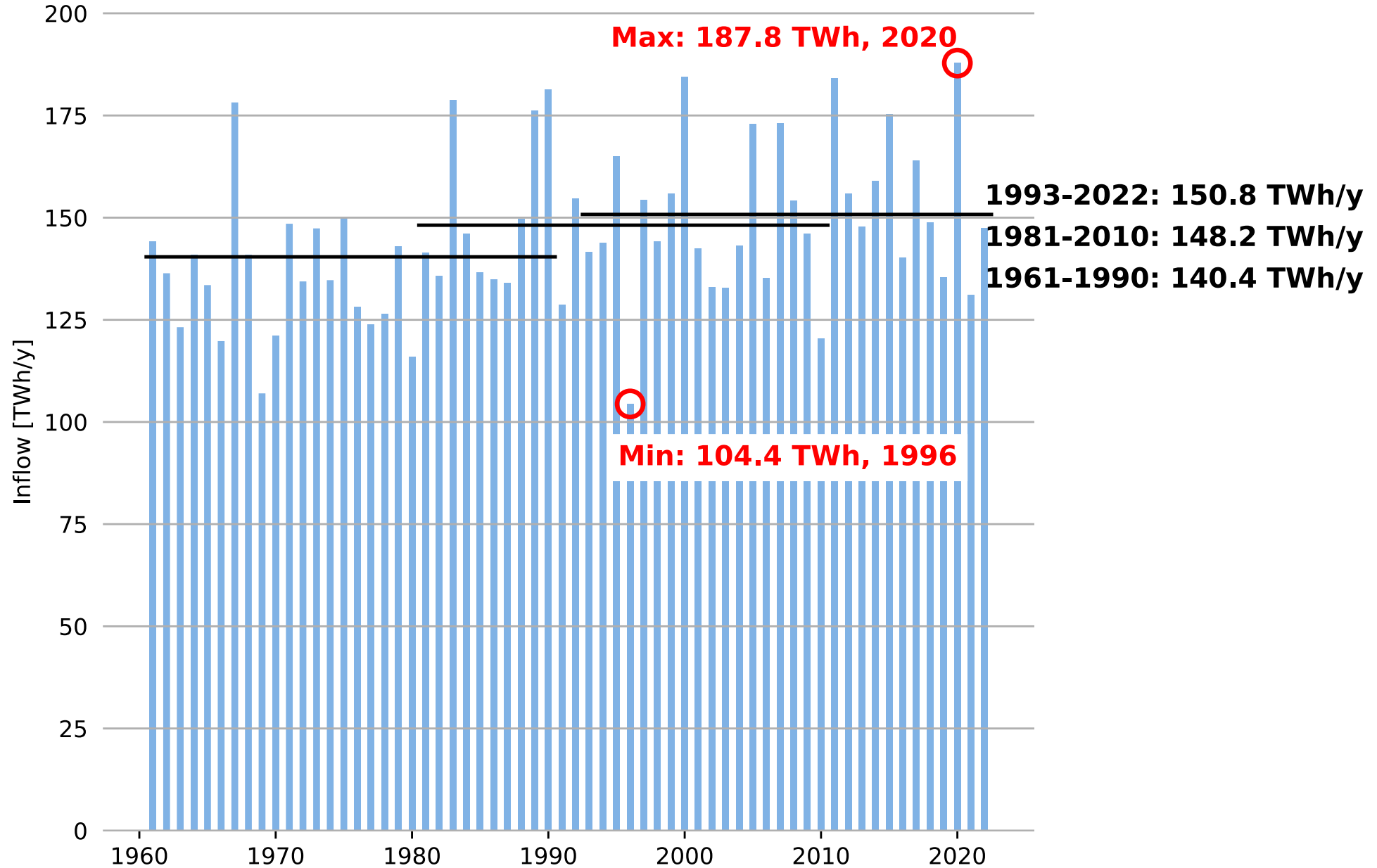

Observed inflow is increasing faster than in the climate projections

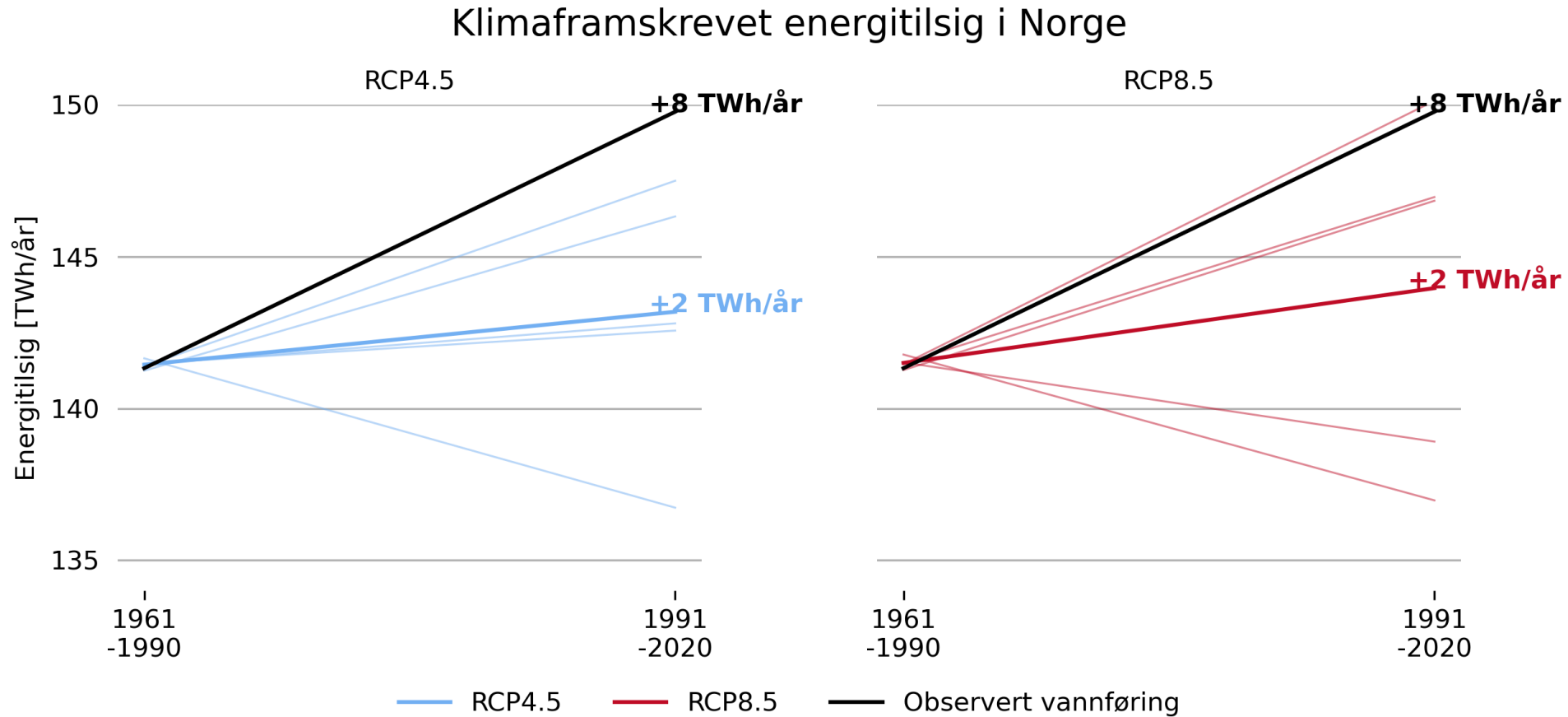



Climate projections indicate that:

- **Annual inflow will continue to increase in the years to come**



Change in climate projected inflow in Norway for RCP8.5

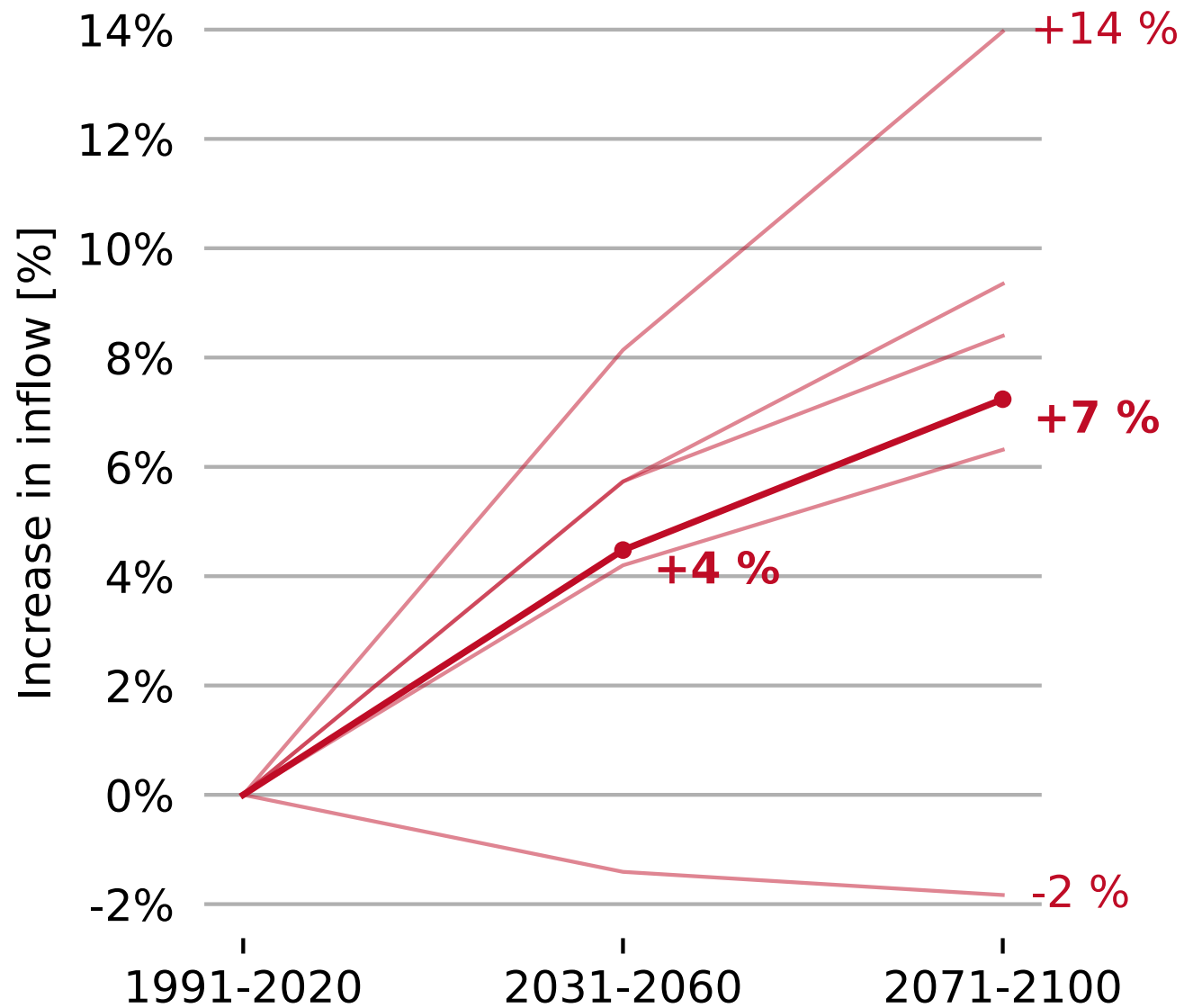



Climate projections indicate that:

- Annual inflow will continue to increase in the years to come
- **The average inflow during the winter will increase**



Inflow profile for Norway for RCP8.5

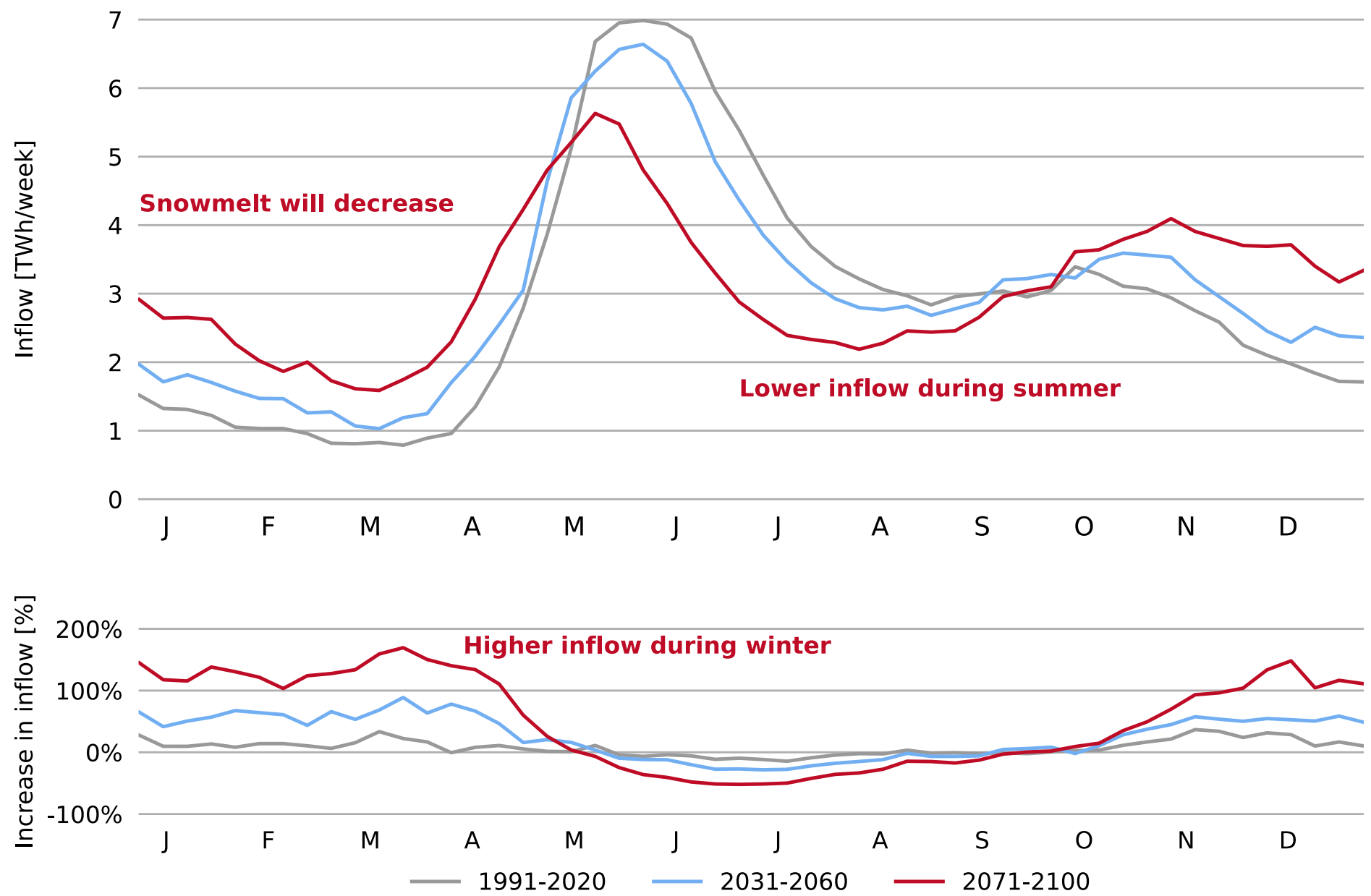



Climate projections indicate that:

- Annual inflow will continue to increase in the years to come
- The average inflow during the winter will increase, **but the inflow during the winter will vary more from year to year**

Duration curve for inflow during winter from climate projections for Norway for RCP8.5

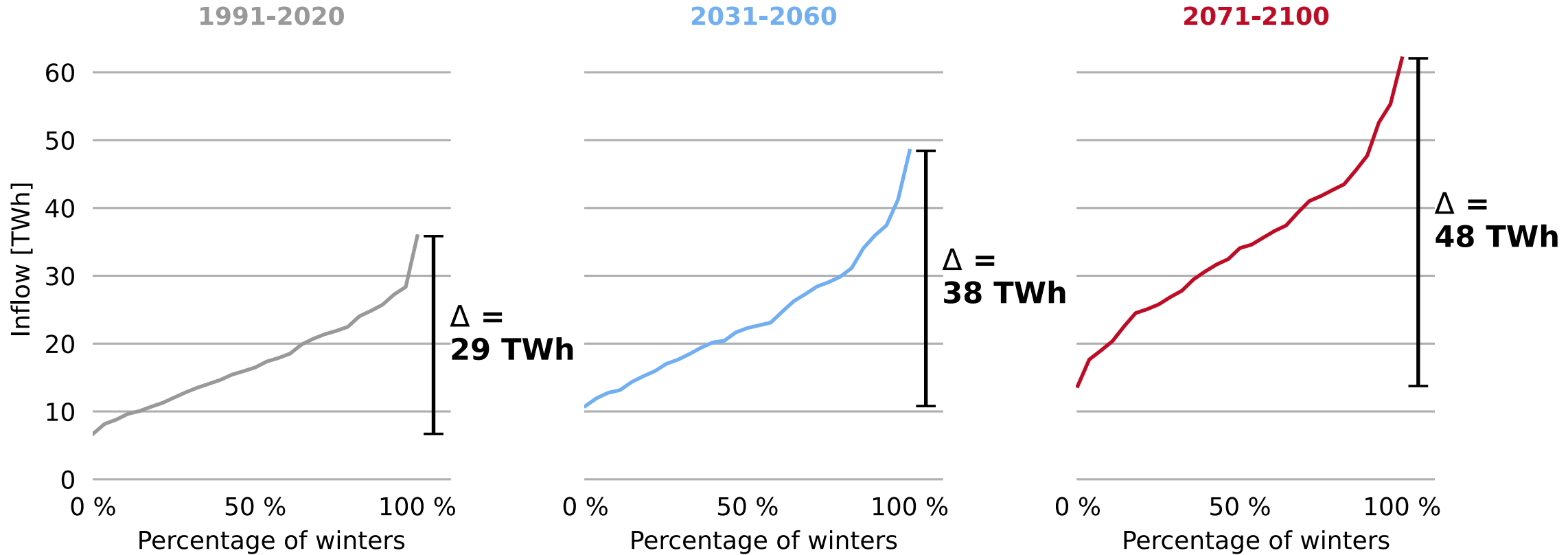



Climate projections indicate that:

- Annual inflow will continue to increase in the years to come
- The average inflow during the winter will increase, **but the inflow during the winter will vary more from year to year**
=> Reservoir management will become more challenging

Climate projections indicate that:

- Annual inflow will continue to increase in the years to come
- The average inflow during the winter will increase, but the inflow during the winter will vary more from year to year
=> Reservoir management will become more challenging
- **Spillage will increase**



Production and spillage in climate projections for Norway for RCP 8.5

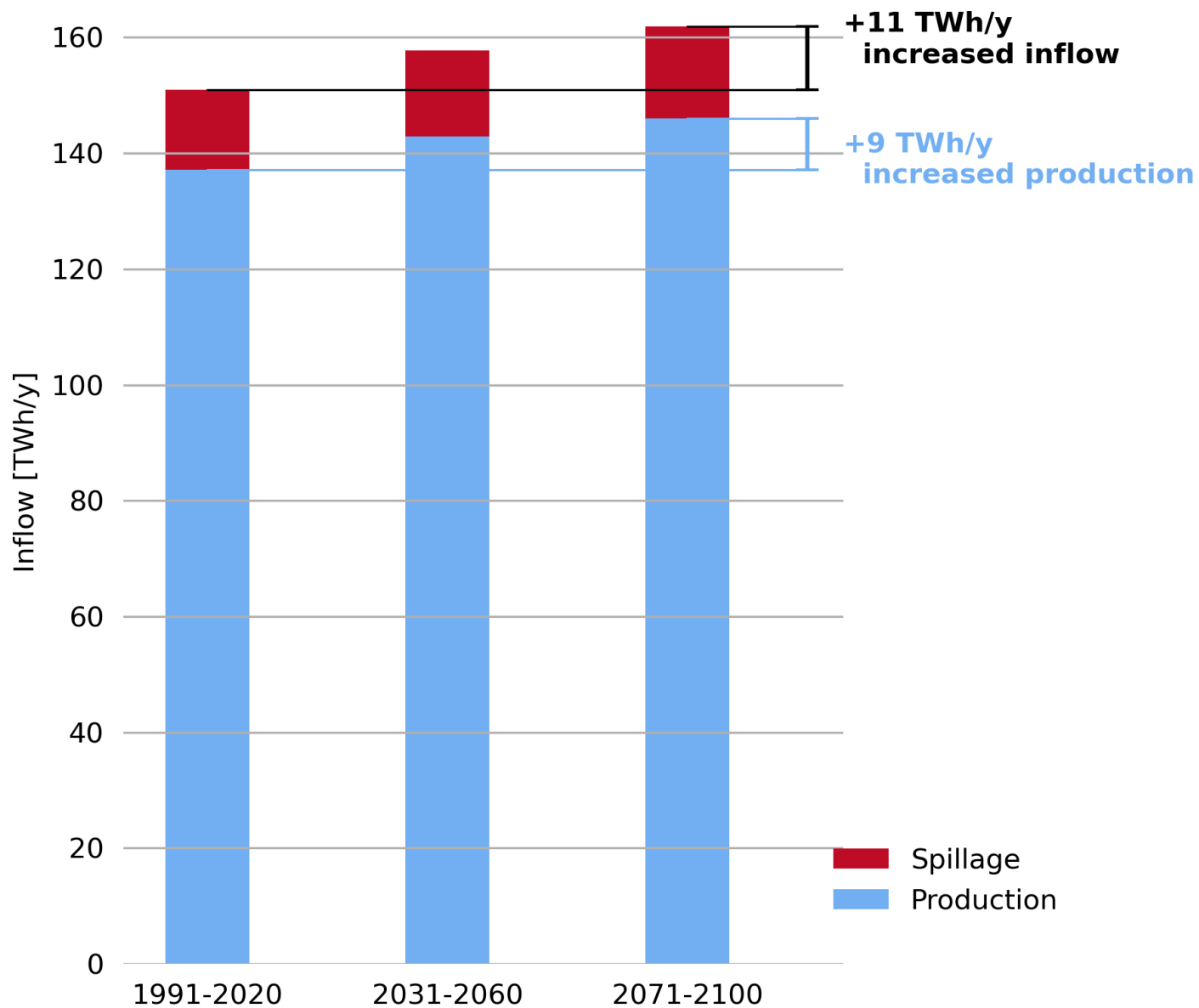



Change in inflow until the end of the century for RCP8.5

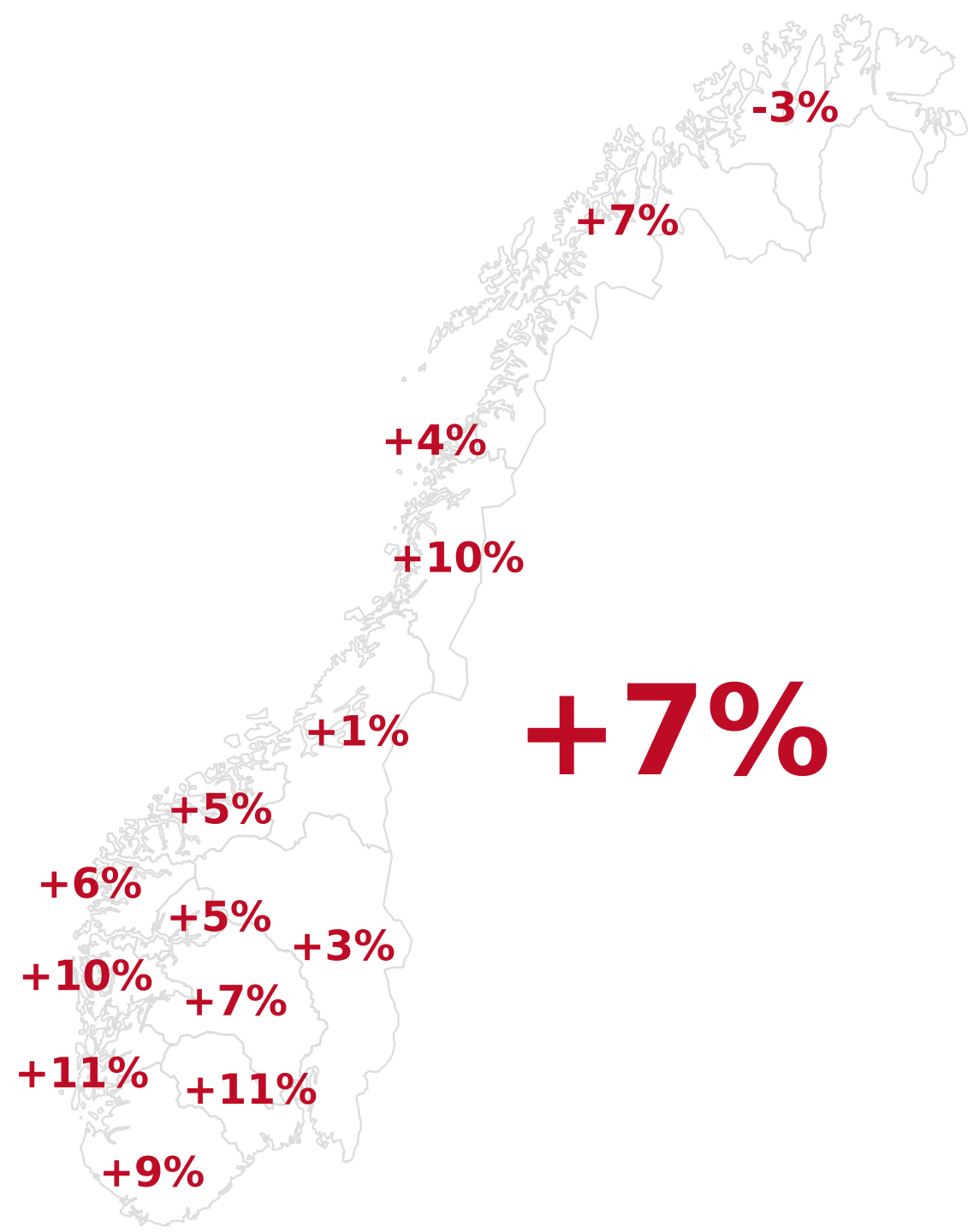

Method

- **Only inflow has been changed between the simulations**
- No changes in the power system, hydropower plants or power prices
- The hydropower has been simulated with a weekly resolution in Vansimtap
- The simulated hydropower system is power plants in operation by the end of 2022

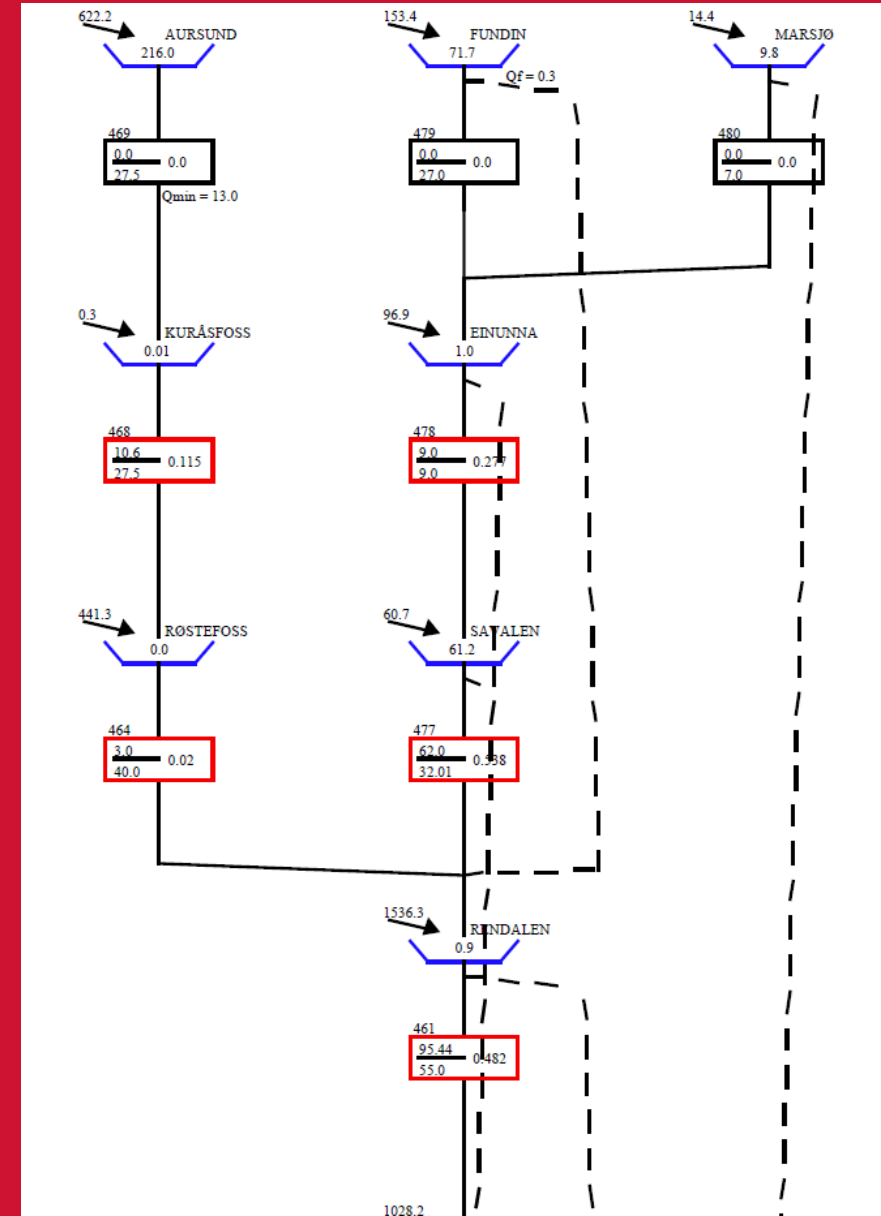



Some remarks so far

- Climate change has already influenced hydropower in Norway, and will continue to do so in the future



Some remarks so far

- Climate change has already influenced hydropower in Norway, and will continue to do so in the future
- Climate projected inflow still has high uncertainty



Some remarks so far

- Climate change has already influenced hydropower in Norway, and will continue to do so in the future
- Climate projected inflow still has high uncertainty
- Use the newest available historical series for production planning

Some remarks so far

- Climate change has already influenced hydropower in Norway, and will continue to do so in the future
- Climate projected inflow still has high uncertainty
- Use the newest available historical series for production planning
- Production planning ahead of winter in a future climate will also be challenging

Some remarks so far

- Climate change has already influenced hydropower in Norway, and will continue to do so in the future
- Climate projected inflow still has high uncertainty
- Use the newest available historical series for production planning
- Production planning ahead of winter in a future climate will also be challenging
- A regional downscaling of new climate datasets will be available soon

Another driver is the renewal of concessions

- The interplay between the environmental restrictions and climate change might be challenging

- Konesjonsvilkårene har ikke tatt høyde for et scenario uten vårflom. Dette er nytt for alle. Det er ukjent farvann, mener avdelingslederen i Glitre som tilbrakte søndagen på kontoret blant regneark og værprognoser.



Increased wind production during winter might also influence the reservoir strategies

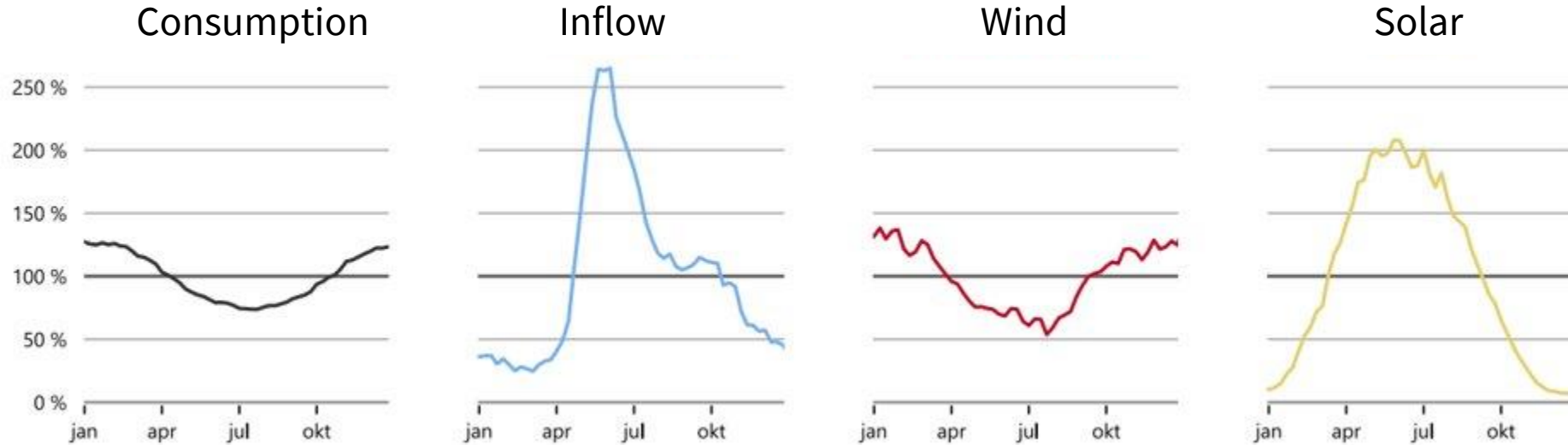

How can we model the impact of climate change on the entire power system?

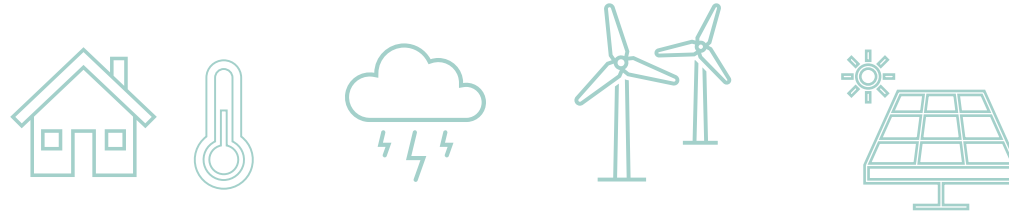

Inflow

Solar

Wind

Thermal

Consumption

And without compromising the correlation between these variables?



Fyllingsgrad

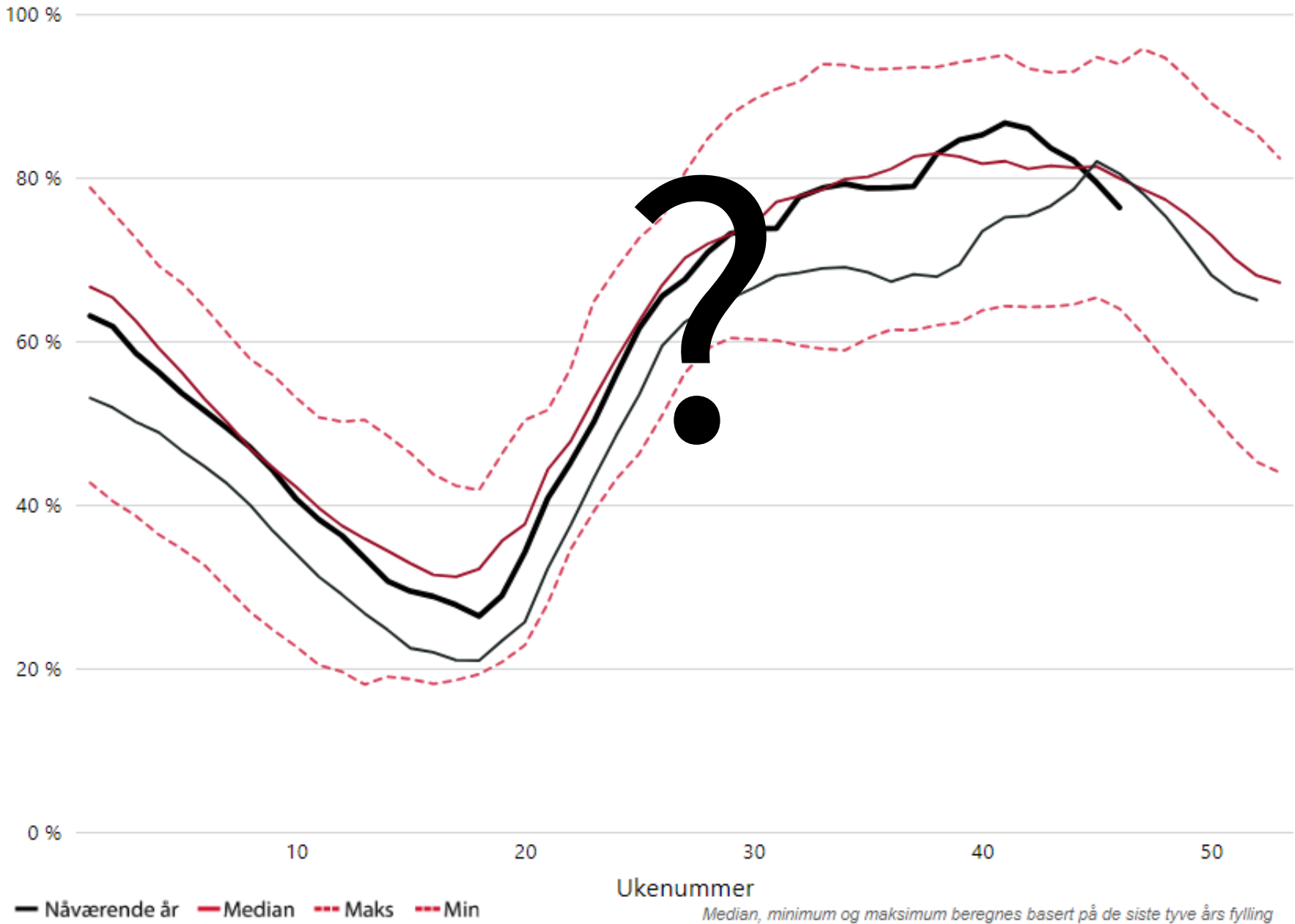

— Nåværende år — Median - - - Maks - - - Min

Median, minimum og maksimum beregnes basert på de siste tyve års fylling

Reports on hydro power and climate change from NVE

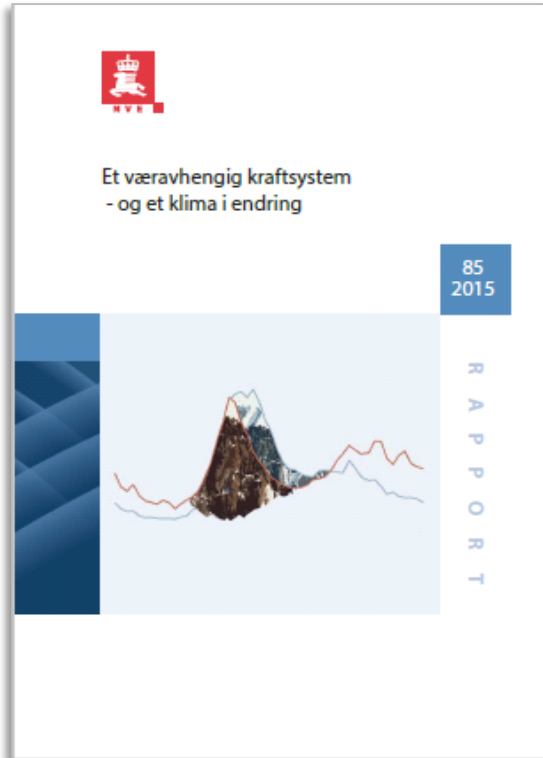

[lenke1](#)



[lenke2](#)



[lenke3](#)



[lenke4](#)

NVE have created a new runoff map for 1991-2020

Mean annual runoff (mm/year) 1991-2020

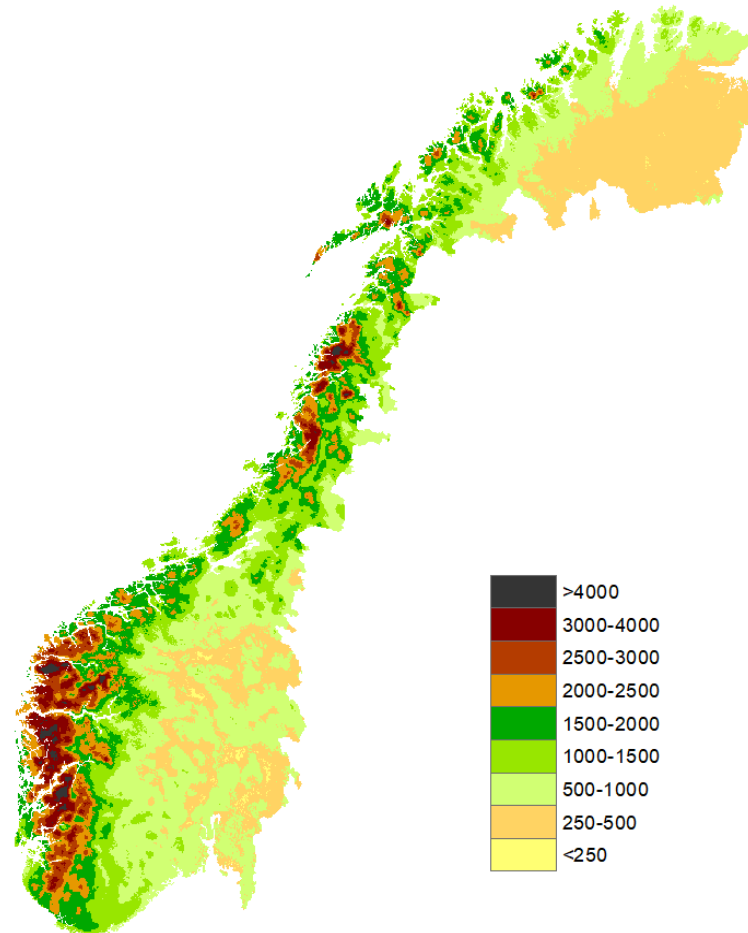

New mean annual production values for hydro power plants for 1991-2020

Mean annual runoff (mm/year) 1991-2020

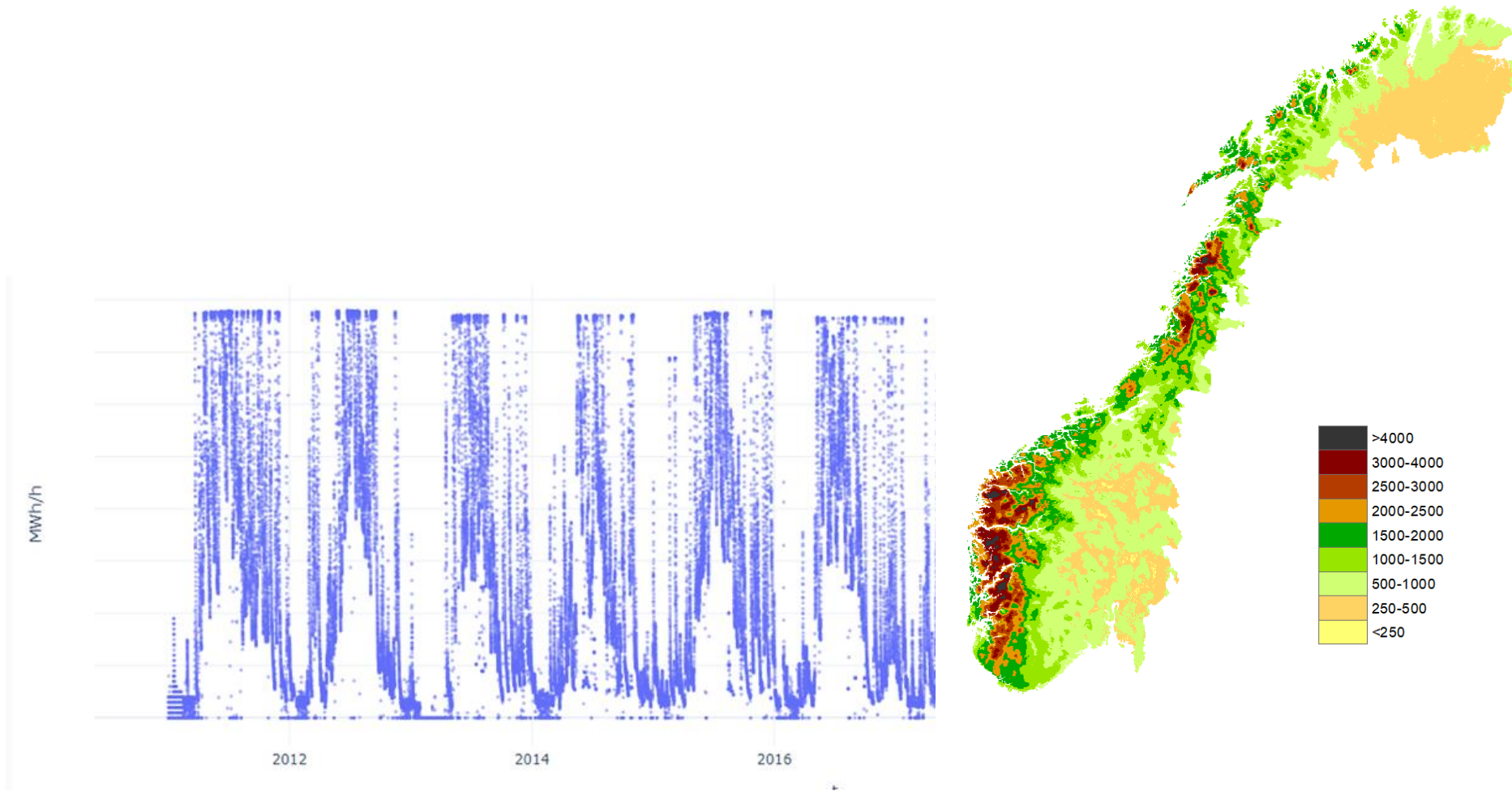



Mean annual production was adjusted down by 1,7 TWh

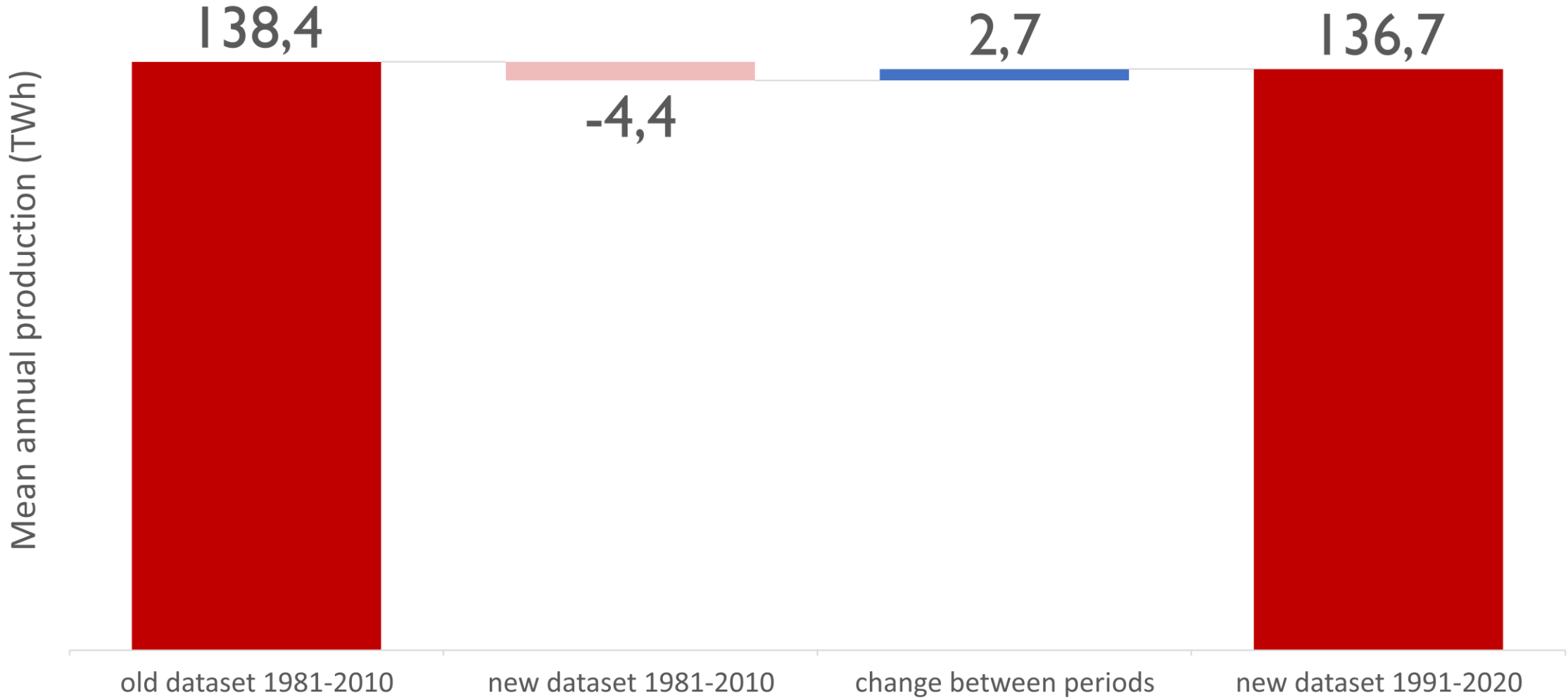

*As of november 2022

For more information about the new production values



FAKTA

Nr 6/2022

Ny midlere årsproduksjon for norske vannkraftverk anslått til 136,7 TWh

Det kan variere mye fra år til år hvor mye tilsig som kommer til norske vannkraftverk. Midlere årsproduksjon brukes derfor for å beskrive den forventede produksjonen til vannkraftverk over tid. Vi beregner midlere årsproduksjon som gjennomsnittlig produksjon over en tilsigsperiode på 30 år. NVE har nå byttet tilsigsperiode fra 1981-2010 til 1991-2020.

NY ÅRSPRODUKSJON ANSLÅTT TIL 136,7 TWH

NVE bruker en referanseperiode på 30 år for å definere midlere årsproduksjon fra vannkraftverk, både utbygde og kraftverk som det søkes om tillatelse til å bygge. Vi oppdaterer referanseperioden hvert tiende år. Siste oppdatering ble gjort i 2012¹. Ved å oppdatere til en nyere referanseperiode, vil man få et anslag for midlere årsproduksjon som bedre representerer dagens nivå.

Vi har beregnet ny midlere årsproduksjon for norsk vannkraft til 136,7 TWh for tilsigsperioden 1991-2020. Dette erstatter det gamle anslaget på 138,4 TWh for tilsigsperioden 1981-2010. Tallene omfatter kraftverk som er satt i drift per 01.11.2022.

NVEs vannkraftdatabase er oppdatert med midlere årsproduksjon for 1991-2020 for alle vannkraftverk². Datasett for simulering av vannkraftsystemet i Norge med oppdatert hydrologisk grunnlag er tilgjengelig på nve.no³.

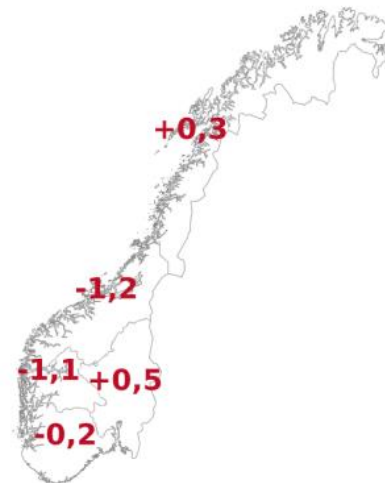

Figur 1: Endring i midlere årsproduksjon per prismråde fra 1981-2010 til 1991-2020. Total nedgang er 1,7 TWh.

Some ongoing work in NVE today

- More hydrological series in modelling

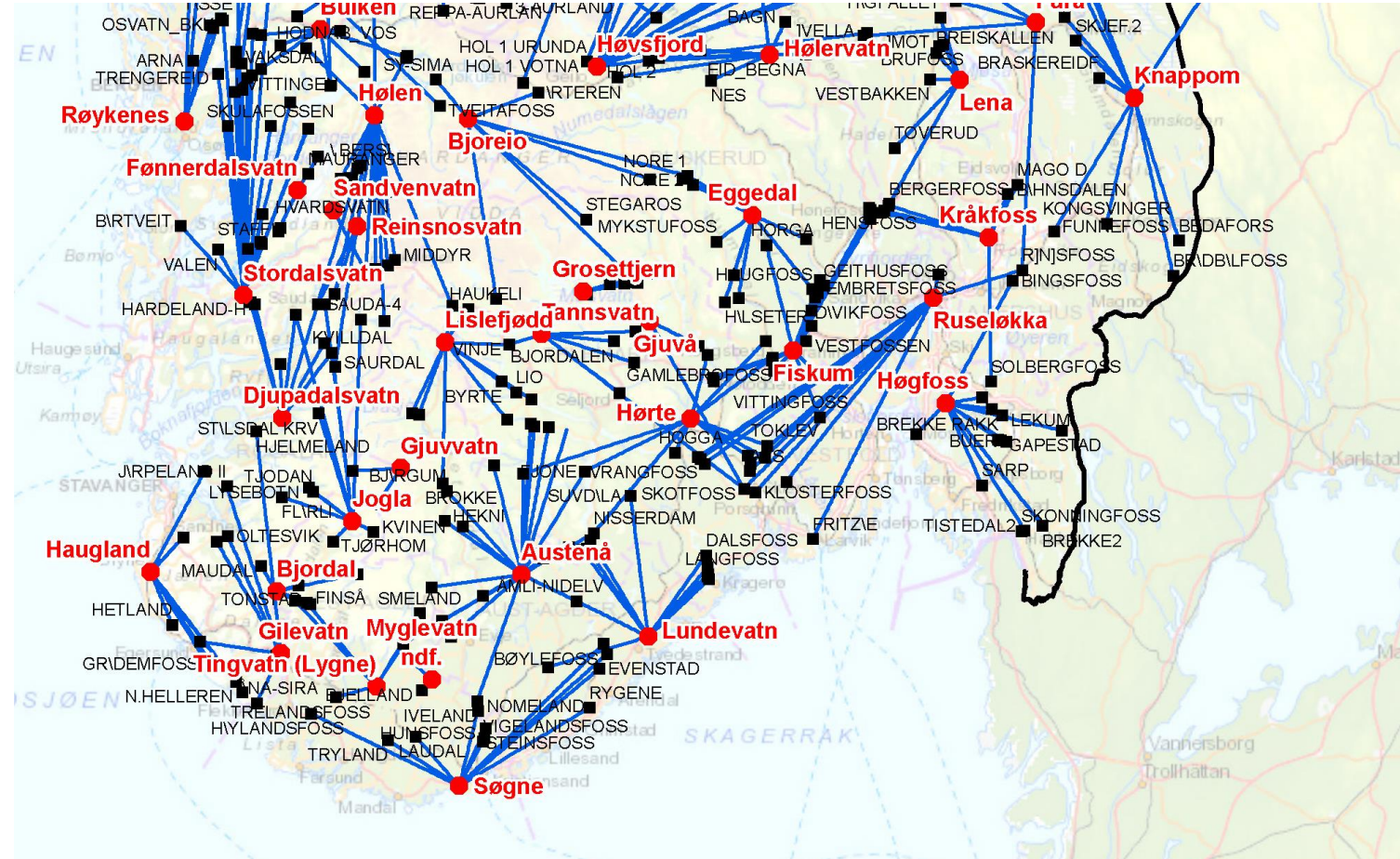

More hydrological data is available in our Power BI-report





Model of the Noregian hydro power system can be downloaded from nve.no



VANN OG VASSDRAG ▾ ENERGI ▾ NATURFARE ▾ AREALPLANLEGGING KART KONSESJON OM NVE

Forside > Energi > Energisystem > Vannkraft > Modell av det norske vannkraftsystemet

Publisert 12.12.2022, sist oppdatert 16.01.2023

Modell av det norske vannkraftsystemet

NVE har laget et vannkraftmodelldatasett for det norske vannkraftsystemet. Dette datasettet er åpent tilgjengelig for bruk, og kan lastes ned både i DETD-format og i excelformat. Tilsiget til datasettet er basert på NVEs nye avrenningskart for 1991-2020.

Datasettet på DETD-format kommer i to forskjellige utgaver.

- Det ene inneholder én fil per vassdrag for om lag 100 vassdrag i Norge. Dette inkluderer alle større kraftverk (>10 MW) og en del småkraftverk som får regulert tilsig. Om lag 670 av 1705 kraftverk inngår i denne utgaven av datasettet.
- Den andre utgaven inneholder én detd-fil for hvert av de 15 samkjøringsmodellområdene (EMPS-områdene). Dette er en sammenstilling av vassdragene som ligger i samme område, og kan brukes til modellering av vannkraftsystemet i Samkjøringsmodellen. Denne utgaven inkluderer også samlemoduler per EMPS-område for småkraft i området som ikke er detaljmodellert.

Datasettet kan lastes ned fra menyen til høyre, sammen med en innholdsbeskrivelse. Vi tar forbehold om at det finnes feil og mangler i enkeltvassdrag, og at det noen steder er gjort skjønsmessige korrigeringer av inputparametere. Si gjerne fra dersom du finner større feil eller mangler ved bruk av datasettet.

Data for nedlastning

[Modell av norsk vannkraft \(DETD-format\)](#)

[Modell av norsk vannkraft \(Excel-format\)](#)

[Beskrivelse av datasettet](#)

[Koblingsstabell mellom vannkraftmodell og NVEs vannkraftdatabase](#)

[Kart over EMPS-områder og prisområder](#)

Lenker

[Historiske vannføringsserier til produksjonsplanlegging](#)

Kontaktperson:

Carl Andreas Veie (cave@nve.no)

25411 EVANGER

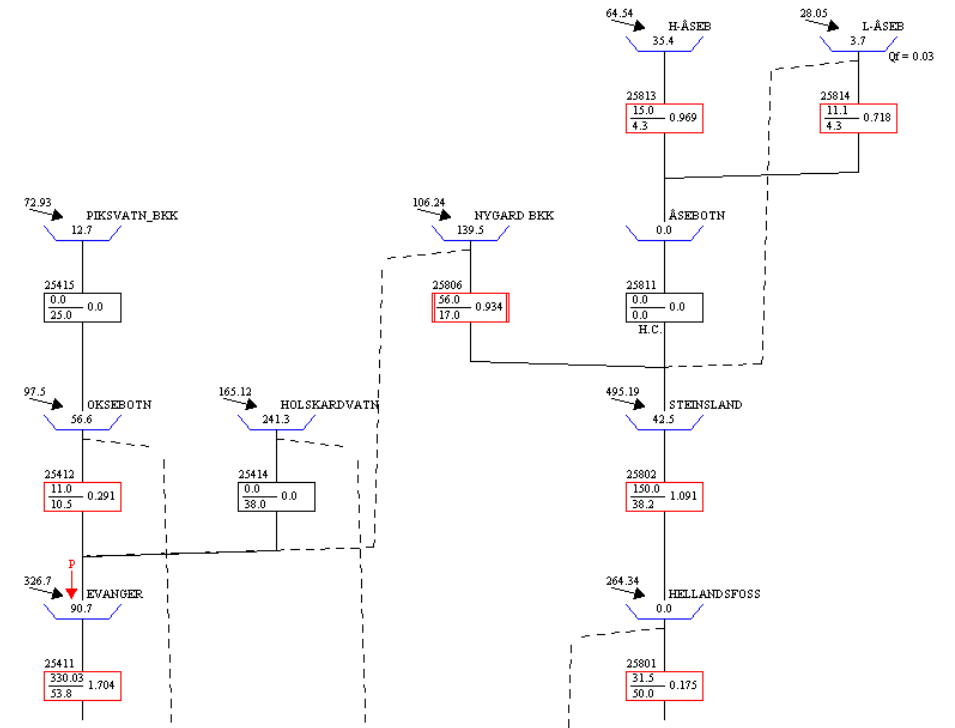



Thanks for listening

Mail: cave@nve.no

- Net inflow = hydropower production + net change in reservoirs
- Gross inflow = inflow in mill. m³ * sum of energy equivalents

Prosentvis endring i 200-års flom ved høyt utslipp (2071-2100 vs. 1991-2020)

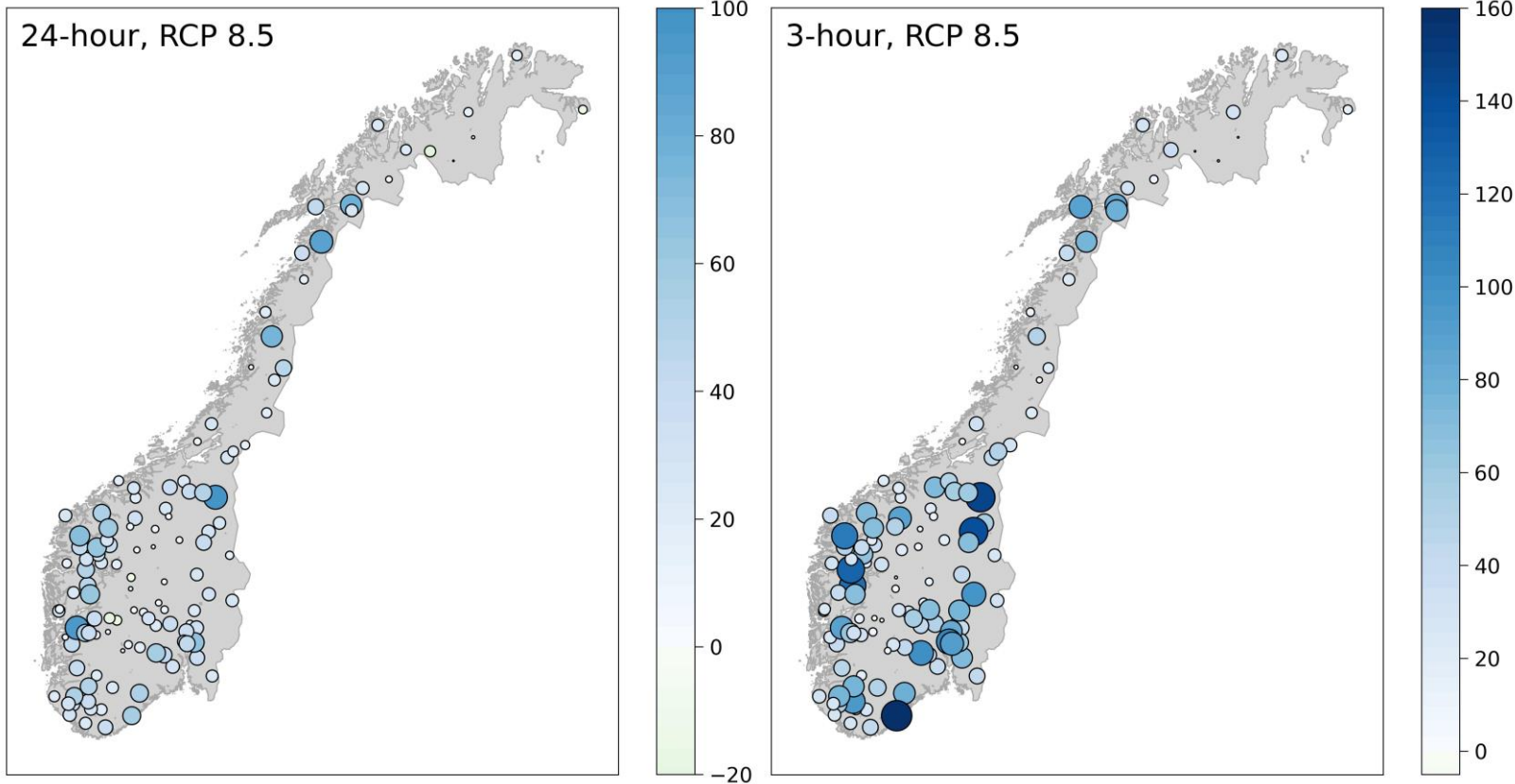

Gjennomsnitt endring (120 nedbørfelt)

	RCP 8.5	
	24-t	3-t
Middelflom	21%	29%
200-års flom	30%	45%

Carr, S. (m.fl.) 2023. Projected changes in peak flows and implications for climate change allowances.
NVE Rapport 26/2023, 41 s.



The variations between years will not increase
(according to the climate models)

Duration curve for annual inflow
from climate projections for Norway for RCP8.5

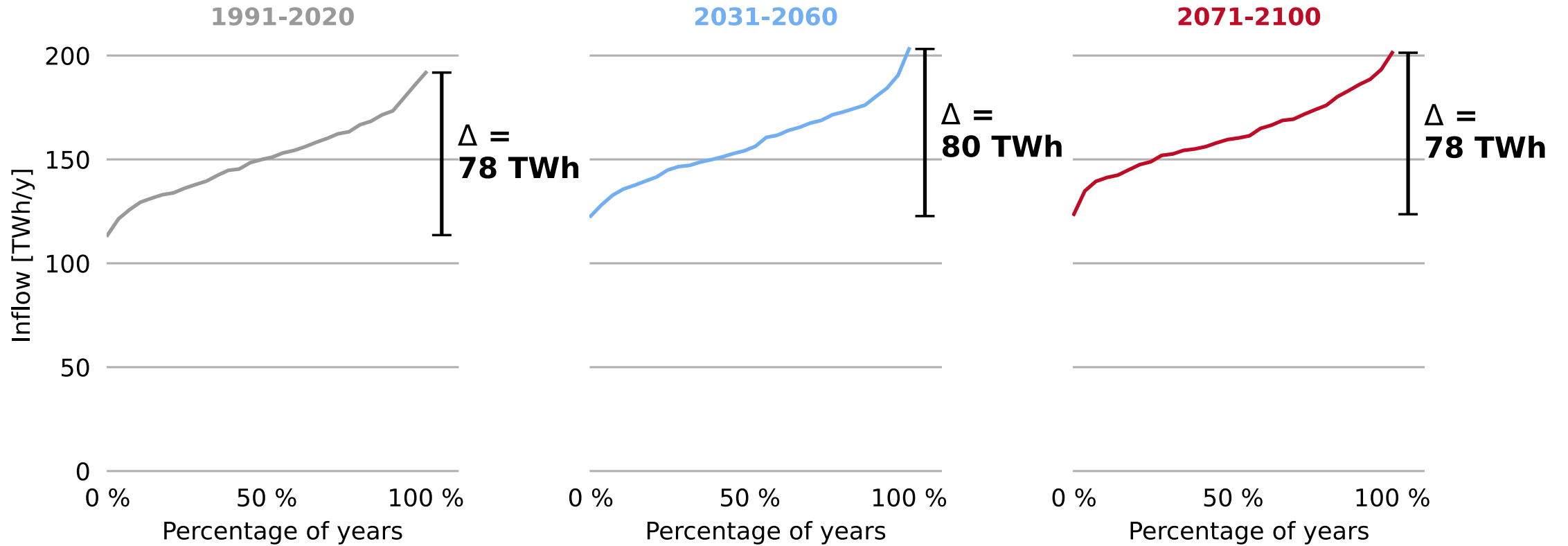



If you want everything in one figure:

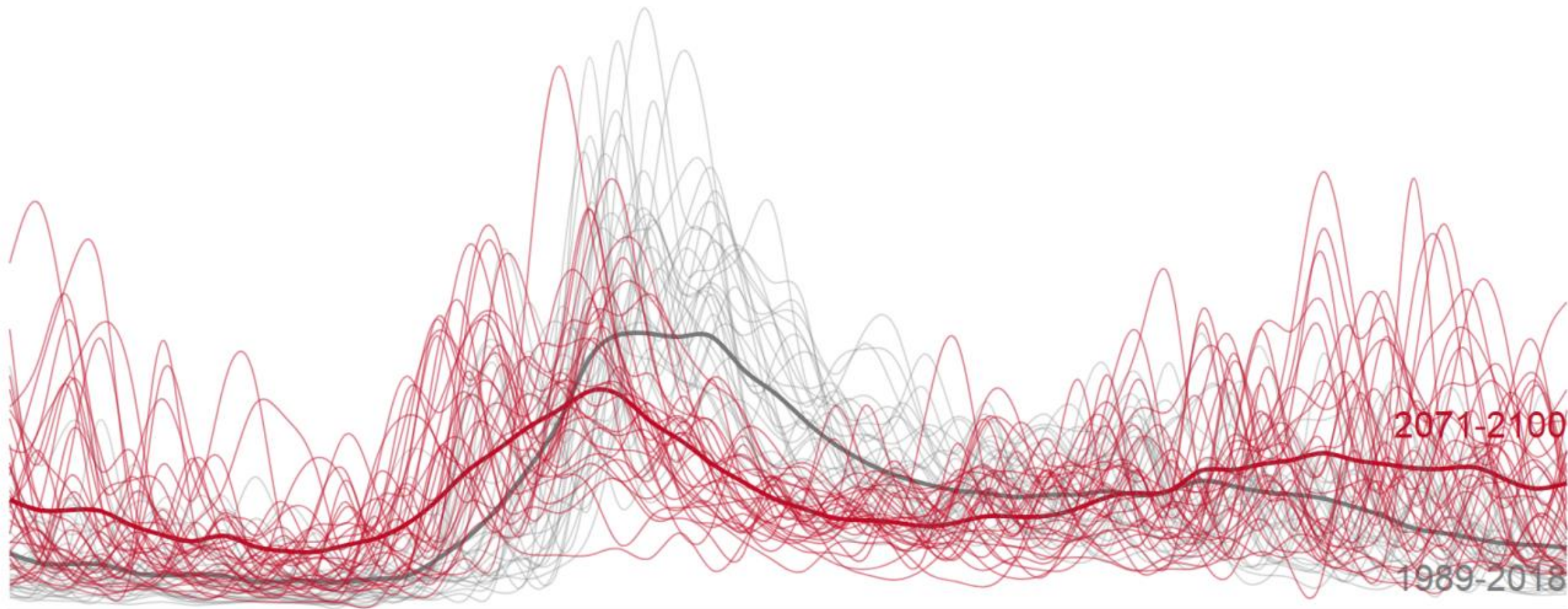

Five different climate models have been used for two different emission scenarios (RCP 4.5 and RCP 8.5)

Tabell 3: Oversikt over kombinasjonene av globale og regionale klimamodeller som ligger bak framskrivningene av temperaturer og tilsig. Alle kombinasjonene er kjørt i både et høyutslippsscenario (RCP8.5) og et utslippsscenario som ligger nær togradersmålet (RCP4.5).

Global klimamodell	Regional klimamodell	Tidsperiode (tilsigsserier)	Institusjon
CNRM	CCLM	1961-2100	Climate Limited-area Modelling Community
EC-EARTH	CCLM	1961-2100	Climate Limited-area Modelling Community
EC-EARTH	HIRHAM	1961-2100	Danish Meteorological Institute
EC-EARTH	RACMO	1961-2100	Royal Netherlands Meteorological Institute
MPI	CCLM	1961-2100	Climate Limited-area Modelling Community

Energitilsigsprofil i Norge fra observert vannføring

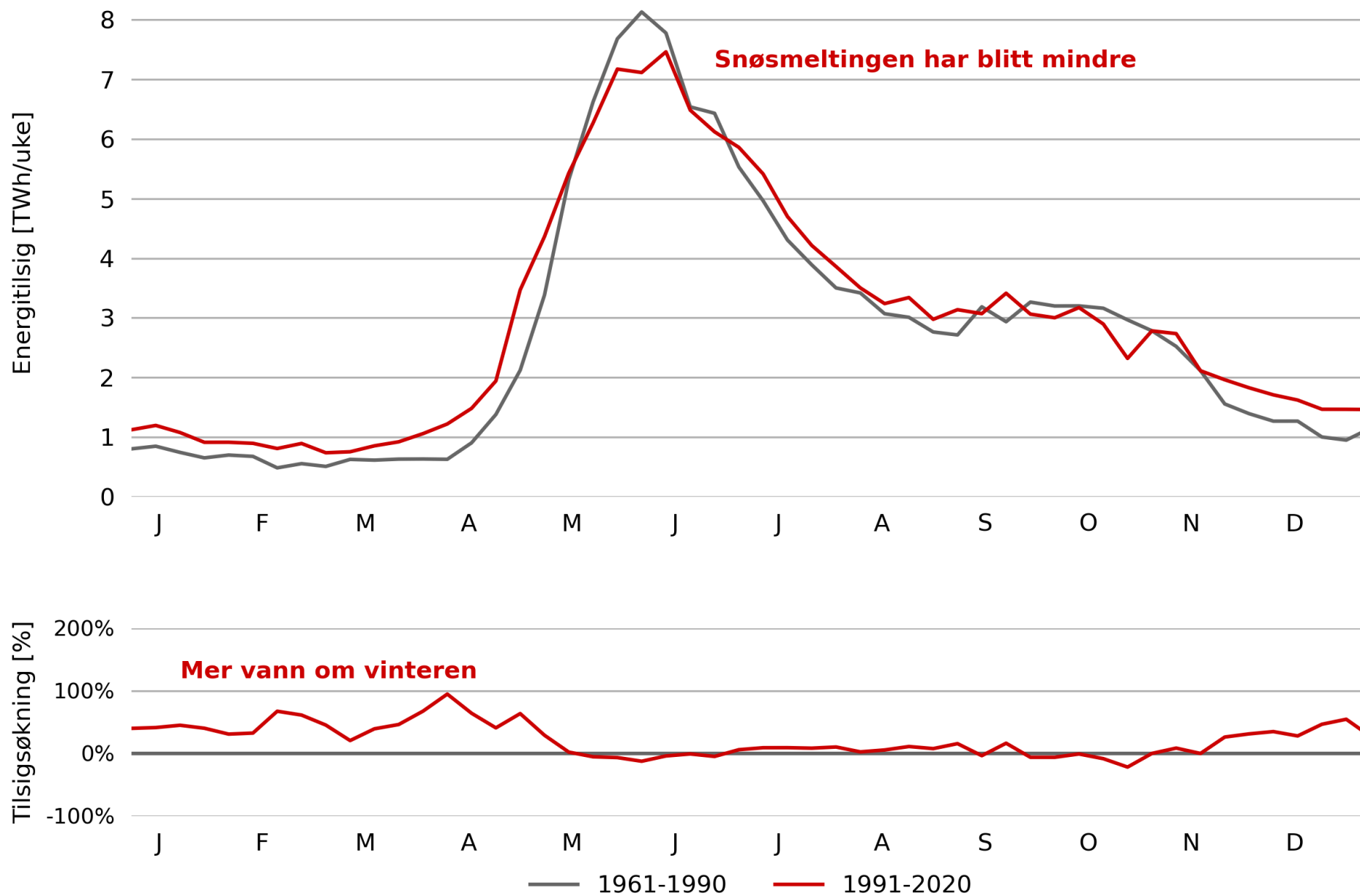

Production and spillage from observed discharge in Norway

